



## InGage Regulator



- Unique Adjustable Internal Pressure Gauge
- Unique Double Filter System
- Unique Dome Handle
- Unique Yoke Washer Seal
- Unique Swivel Yoke & Body
- Unique Dodecagon (12 sided) shape
- Unique Thread Insert Design
- Unique Custom Laser Etching available
- MRI Conditional
- 16 Medical Gas configurations
- 14 Different Anodized Colors
- All Metal Construction, available in  
 Anodized Aluminum, Tri-Metal or 23k Gold  
 Plated Brass, Stainless Steel
- FDA CGMP (CFR 21, Parts 803-821)
- ISO13485
- MDSAP
- RoHS



Part Number	Description	
DR8033-7003P4	CGA 870, 0-25 LPM, Hose Barb	
DR8133-7003P4	CGA 870, One DISS-1240 Check Valve, 0-25 LPM, Hose Barb	
DR8333-7003P4	CGA 870, Two DISS-1240 Check Valves, 0-25 LPM, Hose Barb	
DR5103-6003	CGA 540, One DISS Check Valve, Pressure Reducer, Plain Cap	
DR5303-6003	CGA 540, Two DISS Check Valves, Pressure Reducer, Plain Cap	
DR5303-7003P4	CGA 540, Two DISS-1240 Check Valves, 0-25 LPM, Hose Barb	



## InGage Regulator for Medical Gases

- Including all the unique features of the InGage Regulator, Flotec has a complete offering of this extremely durable regulator for all Medical Gases listed below. All others are available on request.
- Shown with Hose Barbs except where noted, DISS fittings available for each Medical Gas
- Shown with CGA suggested colors, ISO colors for each gas available or non-gas specific option
- Shown with 0-25 LPM flow range accept were noted as PR only, other flows available

Part Number	Gas	GGA	Description	CGA color
DR2002-7002P4	None		1/4" FNPT	Silver
DRC002-7002P4	Carbon Dioxide	CGA 320	Hex Nut & Nipple	Silver
DRL002-7002P4	Carbon Dioxide <7% & Oxygen Mix	CGA 880	Yoke Assembly	Silver
DRT002-7002P4	Carbon Dioxide <7% & Oxygen Mix	CGA 280	Knurled Nut & Nipple	Silver
DR7002-7002P4	Carbon Dioxide >7% & Oxygen Mix	CGA 940	Yoke Assembly	Silver
DRQS07-6007	Helium, DISS-1060	CGA 890	Hex Nut & Nipple, PR only	Brown
DRE037-7003P4	Helium 70% & Oxygen 30%	CGA 890	Yoke Swivel Body & Dome	Brown & Green
DRM037-7003P4	Helium 80% & Oxygen 20%	CGA 890	Yoke Swivel Body & Dome	Brown & Green
DRK007-7003P4	Helium >80% & Oxygen Mix	CGA 930	Yoke Assembly	Brown & Green
DRH007-7003P4	Helium 60% & Oxygen 40%	CGA 280	Knurled Nut & Nipple	Brown & Green
DRF007-7003P4	Helium 70% & Oxygen 30%	CGA 280	Knurled Nut & Nipple	Brown & Green
DRB007-7003P4	Helium 80% & Oxygen 20%	CGA 280	Knurled Nut & Nipple	Brown & Green
DR4004-7004P4	Medical Air	CGA 346	Knurled Nut & Nipple	Yellow
D0P004-7004P4	Medical Air (4500 psi)	CGA 347	Knurled Nut & Nipple	Yellow
DR9034-7004P4	Medical Air	CGA 950	Yoke Swivel Body & Dome	Yellow
DRA202-6002	Medical Gas Mix, 1/8" FNPT	CGA 500	Hex Nut & Nipple, PR only	Silver
DR3202-6002	Medical Gas Mix, 1/8" FNPT	CGA 973	Yoke Assembly, PR only	Silver
DRN202-6002	Nitric Oxide, 1/8" FNPT	CGA 660	Hex Nut & Nipple, PR only	Silver
DRR202-6002	Nitric Oxide Mix, 1/8" FNPT	CGA 620	Hex Nut & Nipple, PR only	Silver
DR1009-7009P4	Nitrogen	CGA 580	Hex Nut & Nipple	Black
DRD009-7009P4	Nitrogen	CGA 960	Yoke Assembly	Black
DRJM05-6005	Nitrous Oxide, DISS-1040	CGA 910	Yoke Assembly, PR only	Blue
DRXM05-6005	Nitrous Oxide, DISS-1040	CGA 326	Hex Nut & Nipple, PR only	Blue
DR6035-7005P4	Nitrous Oxide & Oxygen Mix	CGA 965	Yoke Swivel Body & Dome	Blue
DR5003-7003P4	Oxygen	CGA 540	Knurled Nut & Nipple	Green
DR8033-7003P4	Oxygen	CGA 870	Yoke Swivel Body & Dome	Green
DRU0F2-70F2P4	Oxygen (58 psi (4 bar))	BS 341 #3	Hex Nut & Nipple	Silver
DRG0F2-70F2P4	Oxygen (58 psi (4 bar))	DIN 477-9	Hex Nut & Nipple	Silver
DRS0F2-70F2P4	Oxygen (58 psi (4 bar))	Swedish	Hex Nut & Nipple	Silver



## InGage Regulator for Auxiliary Equipment

- Match Ambulance Flowmeter outlets with Regulator outlets for quicker transfers.
  - DISS Check Valve
  - Ohio Quick Disconnect
  - Chemetron Quick Disconnect
  - 1/8" FNPT Pipe Port
  - Stainless Steel Hansen (Canada)
  - SIS Check Valve (Australia)



Part Number	Description	
DR8E33-7003P4	CGA 870, One Ohio & One Check Valve, 0-25 LPM, Hose Barb	
DR8Q33-7003P4	CGA 870, One Chemetron & One Check Valve, 0-25 LPM, Hose Barb	

## RW Series Regulator (Regulator with a Window)

- Unique Glow in the Dark Flow Numbers
- Unique Double Filter System
- Unique Thread Insert Design
- Unique selection of 14 Different Anodized Colors
- Low Profile Gauge
- MRI Conditional
- Anti-Blowout Design (no snap rings)
- Heavy Duty Service with Outstanding Impact Resistance
- Soft Seat, Finger Tight Post Valve Seal with Stay-Put Design
- All Metal Construction (available in Anodized Aluminum, Plated Brass, and Stainless Steel)
- 38 Flow Ranges with 12 Positions of Flow at 20 psi, 30 psi, 50 psi, 58 psi (4 bar) and 70 psi
- FDA CGMP (CFR 21, Parts 803-821), ISO13485, MDSAP and CE Mark

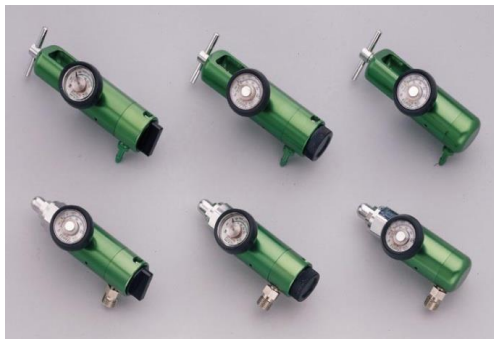



Part Number	Description
RR800-300P4	CGA 870, 0-25 LPM, Hose Barb (Green)
RR810-300P4	CGA 870, One DISS-1240 Check Valve, 0-25 LPM, Hose Barb (Green)
RR830-300P4	CGA 870, Two DISS-1240 Check Valves, 0-25 LPM, Hose Barb (Green)
RR510-600	CGA 540, One DISS Check Valve, Pressure Reducer, Plain Cap (Green)
RR510T-600	CGA 540, Brass Body, One DISS Check Valve, Pressure Reducer, Plain Cap (Green)
RZ516-600	CGA 540 w/ Knurled Nut, Gauge Port and Transducer port w/ 1/8" to 1/4" Adapter, One DISS Check Valve, Pressure Reducer, Plain Cap



RR800-300P4



RZ516-600



RR8135-2005P4

## Flowmeters

- Unique Glow in the Dark Flow Numbers
- Unique Filter System
- Unique high flow ranges (0-25, 0-30, 0-40, 0-60)
- Unique Resident Nipple Adapter Option
- Unique selection of 14 Different Anodized Colors
- Non-Gravity Sensitive and Vibration resistant
- All Metal construction
- MRI Conditional
- Power Take-Off Option available
- Heavy Duty Service with Outstanding Impact Resistance
- Anti-Blowout Design (no snap rings)
- 29 Flow Ranges with 12 Positions of Flow at 17 PSI, 30 PSI, 50 PSI, 58 PSI (4 bar) and 70 PSI
- FDA CGMP (CFR 21, Parts 803-821), ISO13485, and MDSAP
- **Manufactured exclusively in the United States of America**

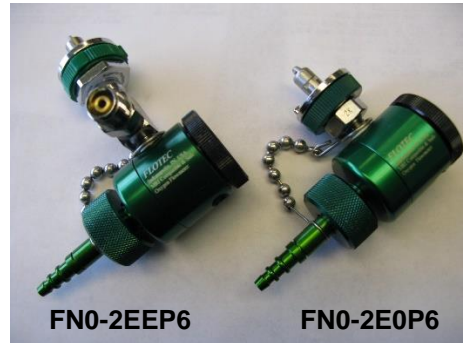

FN0-2EEP6

FN0-2E0P6



F10-2E0P6



F70-200P4



F10-2G0P6



F90-210P4



F00-2C0P6



FN06-2C06P6



Part Number	Description	
F10-2E0P6	Ohio Inlet, 0-25 LPM DISS-1240 Outlet	
F10-2EEP6	Ohio Inlet, 0-25 LPM DISS-1240 Outlet, w/ DISS-1240 Check Valve Power Take-Off	
FN0-2E0P6	Ohio Inlet, 0-25 LPM DISS-1240 Outlet, w/ Resident Nipple Adapter	
FN0-2EEP6	Ohio Inlet, 0-25 LPM DISS-1240 Outlet, w/ Resident Nipple Adapter, w/ DISS-1240 Check Valve Power Take-Off	
F70-210P4	Ohio Inlet, Ceiling Mount, 0-25 LPM DISS-1240 Outlet	
F70-21EP4	Ohio Inlet, Ceiling Mount, 0-25 LPM DISS-1240 Outlet, w/ DISS-1240 Check Valve Power Take-Off	
F10-2G0P6	Chemetron Inlet, 0-25 LPM DISS-1240 Outlet	
F10-2GEP6	Chemetron Inlet, 0-25 LPM DISS-1240 Outlet, w/ DISS-1240 Check Valve Power Take-Off	
FN0-2G0P6	Chemetron Inlet, 0-25 LPM DISS-1240 Outlet, w/ Resident Nipple Adapter	
FN0-2GEP6	Chemetron Inlet, 0-25 LPM DISS-1240 Outlet, w/ Resident Nipple Adapter, w/ DISS-1240 Check Valve Power Take-Off	
F90-210P4	Chemetron Inlet, Ceiling Mount, 0-25 LPM DISS-1240 Outlet	
F90-21EP4	Chemetron Inlet, Ceiling Mount, 0-25 LPM DISS-1240 Outlet, w/ DISS-1240 Check Valve Power Take-Off	
F10-2C0P6	DISS-1240 Knurled Nut & Nipple Inlet, 0-25 LPM DISS-1240 Outlet	
FN0-2C0P6	DISS-1240 Knurled Nut & Nipple Inlet, 0-25 LPM DISS-1240 Outlet, w/ Resident Nipple Adapter	

## Flowmeters on T or Y Blocks

- Unique double Flowmeter T-Block
- Unique Power Take Off Options
- Unique Glow in the Dark Flow Numbers
- Unique Filter System
- Unique Wide flow ranges (0-25, 0-30, 0-40, 0-60)
- Unique Resident Nipple Adapter Option
- Non-Gravity Sensitive
- Vibration resistance
- Custom Colors available
- All Metal construction
- MRI Conditional
- Heavy Duty Service, Outstanding Impact Resistance
- Anti-Blowout Design (no snap rings)
- Unique flow range option, Pediatric and Adult on either Flowmeter
  - “P6” - 12 position Flow range 0, 1, 2, 3, 4, 6, 8, 10, 12, 15, 20, 25
  - “D3” - 12 position Flow range 0, 1/32, 1/16, 1/8, 1/4, 1/2, 3/4, 1, 1-1/2, 2, 3, 4
- FDA CGMP (CFR 21, Parts 803-821), ISO13485, and MDSAP

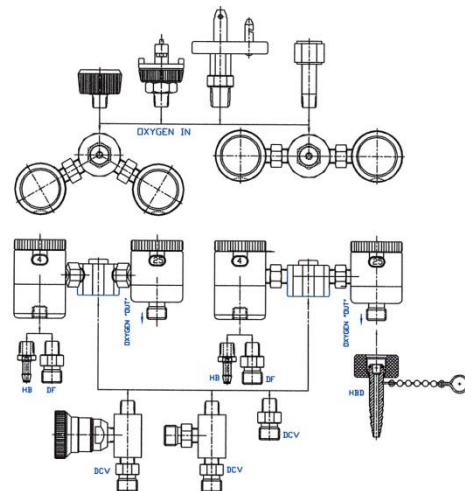



**T10-BEED3P6**



**T10-2EEP6P6**

Part Number	Description	
T10-2E0P6P6	Ohio Inlet, 2 each 0-25 LPM DISS-1240 Outlet on T	
T10-BE0P6P6	Ohio Inlet, 2 each 0-25 LPM DISS-1240 Outlet on Y	
T10-2EEP6P6	Ohio Inlet, 2 each 0-25 LPM DISS-1240 Outlet on T, w/ DISS-1240 Check Valve Power Take Off on the Centerline of the T Block	
TN0-2EEP6P6	Ohio Inlet, 2 each 0-25 LPM DISS-1240 Outlet on T, w/ Two Resident Nipple Adapters, w/ DISS-1240 Check Valve Power Take Off on the Centerline of the T Block	
T10-2E0D3P6	Ohio Inlet, 1 each 0-4 LPM Pediatric, 1 each 0-25 LPM DISS-1240 Outlet on the T	
T10-2EED3P6	Ohio Inlet, 1 each 0-4 LPM Pediatric, 1 each 0-25 LPM DISS-1240 Outlet, w/ DISS-1240 Check Valve Power Take Off on the Centerline of the T Block	
TN0-2EEP6P6	Ohio Inlet, 2 each 0-25 LPM DISS-1240 Outlet on T, w/ Two Resident Nipple Adapters, w/ DISS-1240 Check Valve Power Take Off on the Centerline of the T Block	

Part Number	Description	
T10-2G0P6P6	Chemetron Inlet, 2 each 0-25 LPM DISS-1240 Outlet on T	
T10-BG0P6P6	Chemetron Inlet, 2 each 0-25 LPM DISS-1240 Outlet on Y	
T10-2GEP6P6	Chemetron Inlet, 2 each 0-25 LPM DISS-1240 Outlet on T, w/ DISS-1240 Check Valve Power Take Off on the Centerline of the T Block	
TN0-2GEP6P6	Chemetron Inlet, 2 each 0-25 LPM DISS-1240 Outlet on T, w/ Two Resident Nipple Adapters, w/ DISS-1240 Check Valve Power Take Off on the Centerline of the T Block	
T10-2G0D3P6	Chemetron Inlet, 1 each 0-4 LPM Pediatric, 1 each 0-25 LPM DISS-1240 Outlet on the T	
T10-2GED3P6	Chemetron Inlet, 1 each 0-4 LPM Pediatric, 1 each 0-25 LPM DISS-1240 Outlet, w/ DISS-1240 Check Valve Power Take Off on the Centerline of the T Block	
TN0-2GEP6P6	Chemetron Inlet, 2 each 0-25 LPM DISS-1240 Outlet on T, w/ Two Resident Nipple Adapters, w/ DISS-1240 Check Valve Power Take Off on the Centerline of the T Block	



## Mass Casualty Assemblies

The assembly provides for the rapid triage deployment of six (0 to 25 LPM) Flowmeters or ten (0 to 15 LPM) Flowmeters that can run off the Ambulances onboard oxygen system. This provides the flexibility of individually controlling each patient's LPM requirement. The All-Metal Flowmeters are extremely durable and are non-gravity sensitive. The entire system can be run off any 50 PSI oxygen source capable of delivering 150 LPM.

### Custom Designs available

- Unique 20 foot leader hose provides clearance from the ambulance before the first independent flowmeter
- Unique 6 foot spaces between each flowmeter to provide space to treat each patient with 50 foot overall length
- Unique 2 way swivel Tee configuration
- Unique low (-40 F) temperature hose rating
- Unique lanyards at each flowmeter for hanging on IV poles or wall brackets
- Includes a compact canvas or hard sided carrying case
- Unique Optional DISS 1204 Check Valves for powering a ventilator, aspirator or CPAP
- Unique Optional Drop Hoses available for Mobile Shelter / Hospital applications.
- Includes CGA540 pressure reducing regulator for attachment to large volume cylinder
- **Manufactured exclusively in the United States of America**



MCA-226P7-205X0

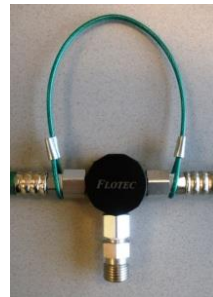

Live Swivel Tee



F5E-270P7

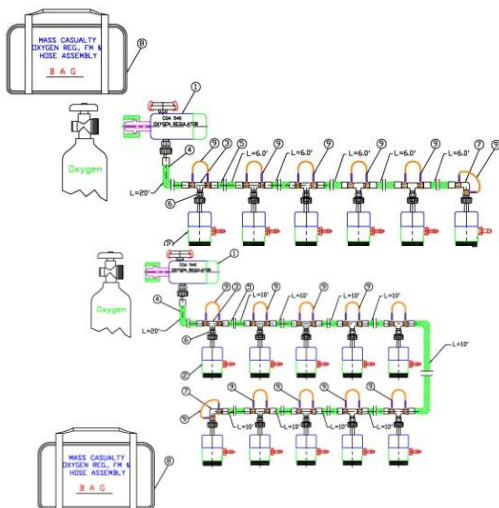

Part Number	Description
MCA-126P7-205X0 <a href="#">(shown)</a>	20 foot leader, six (0-25) flowmeters
MCA-126P7-20FX0	20 foot leader, six (0-25) flowmeters w/ swivel T's
MCA-226P7-20FX0	20 foot leader, six (0-25) flowmeters w/ swivel T's, w/ InGage Regulator

Part Number	Description
MCA-15JM5-20910 <a href="#">(shown)</a>	20 foot leader, ten (0-15) flowmeters
MCA-15JM5-20K10	20 foot leader, ten (0-15) flowmeters w/ swivel T's
MCA-25JM5-20K10	20 foot leader, ten (0-15) flowmeters w/ swivel T's, w/ InGage Regulator



## Multitorr, Mass Casualty Manifolds

- Unique laser engraved Instructions For Use
- Unique all metal construction
- Unique Brass thread insert on Resident Nipple Adapter
- Unique Swivel feature on Resident Nipple Adapter
- **Manufactured exclusively in the United States of America**

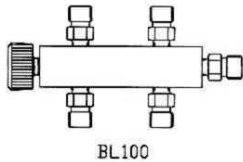

Part Number	Description	
BL100	One DISS-1240 Female Inlet, five DISS-1240 Male Check Valve Outlets	
BL101	One DISS-1240 Female Inlet, five DISS-1240 Male Check Valve Outlets mounted at 45 degrees	
BL151	One DISS-1240 Male Check Valve Inlet, five DISS-1240 Male Check Valve Outlets	
BL151-5x6 w/ 5 each of HDB2-50-6	One DISS-1240 Male Check Valve Inlet, five DISS-1240 Male Check Valve Outlets with five Resident Nipple adapters with 6 LPM orifices	

Part Number	Description	List
BL300	One DISS-1240 Female Inlet, Seven DISS-1240 Male Check Valve Outlets	145.00
BL301	One DISS-1240 Female Inlet, Seven DISS-1240 Male Check Valve Outlets mounted at 45 degrees	215.00

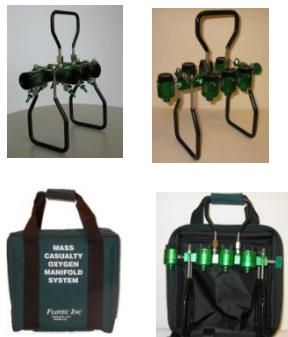
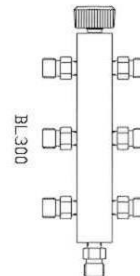

Part Number	Description	
BL500-FD0-2V0P4	Multitorr Stand w/ 7 Horizontal Flowmeters w/ hose barbs mounted at 45 degrees, Female DISS-1240 swivel inlet	
BL500-F10-320M3	Multitorr Stand w/ 7 Vertical Flowmeters w/ male DISS-1240, Female DISS-1240 swivel inlet	
BML750	Canvas Bag Double Zipper Double Handle	





## Resident Nipple Adapters

- ALL Metal Construction for Durability and Reliability
- Knurled Nut Swivels over Nipple for ease of use and prevents tube kinks
- O-ring seal for maximum leak prevention
- Stainless Steel chain and connecting ring to enhance ease of use and to prevent loss
- 2- 1/2" Standard chain length with other lengths available
- Three Barbs for use with a wide variety of tubing
- All adapters are cleaned for oxygen service
- Available in Seven different Colors of Anodized Aluminum
- Knurled Nuts for easy identification of different flows
- Available with fixed flow orifices of 0.5 LPM to 25 LPM
- Flow orifices available in 20 psi, 50 psi and 58 psi
- **Manufactured exclusively in the United States of America**

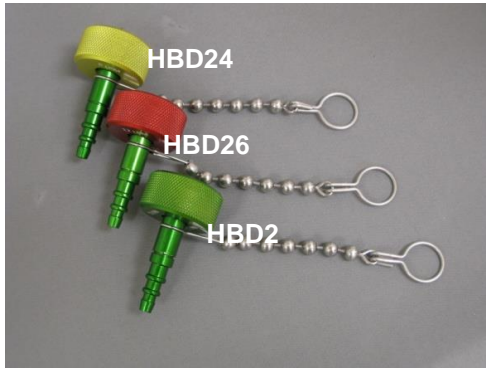
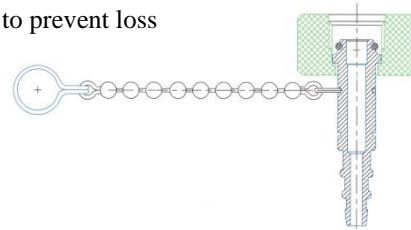

Part Number	Description	
HBD22	Green Hose Barb and Silver Knurled Nut w/ 2-1/2" Chain	
HBD2	Green Hose Barb and Green Knurled Nut w/ 2-1/2" Chain	
HBD24	Green Hose Barb and Yellow Knurled Nut w/ 2-1/2" Chain	
HBD25	Green Hose Barb and Blue Knurled Nut w/ 2-1/2" Chain	
HBD26	Green Hose Barb and Red Knurled Nut w/ 2-1/2" Chain	
HBD29	Green Hose Barb and Black Knurled Nut w/ 2-1/2" Chain	
HBD2A	Green Hose Barb and Purple Knurled Nut w/ 2-1/2" Chain	

Available without Chain Length or extra Chain Length

Part Number	Description	
HBD0	Green Hose Barb and Silver Knurled Nut no Chain	
HBD2	Green Hose Barb and Green Knurled Nut w/ 2-1/2" SS Chain	
HBD44	Green Hose Barb and Yellow Knurled Nut w/ 4" SS Chain	
HBD65	Green Hose Barb and Blue Knurled Nut w/ 6" SS Chain	
HBD86	Green Hose Barb and Red Knurled Nut w/ 8" SS Chain	
HBDA9	Green Hose Barb and Black Knurled Nut w/ 10" SS Chain	



Brass Orifice Insert for precise flow control

Available in 20 psi, 50 psi, or 4 BAR (58 psi)

- HBD2-20-xx**                      20 PSI
- HBD2-50-xx**                      50 PSI
- HBD2-58-xx**                      4 Bar (58 PSI)

Flows indicated twice on Nut

Pressure indicated twice on

20 psi & 4 BAR (58 psi) only

- HBD2-50-2**                      2 LPM @ 50 PSI
- HBD2-50-4**                      4 LPM @ 50 PSI
- HBD2-50-6**                      6 LPM @ 50 PSI
- HBD2-50-8**                      8 LPM @ 50 PSI
- HBD2-50-10**                    10 LPM @ 50 PSI

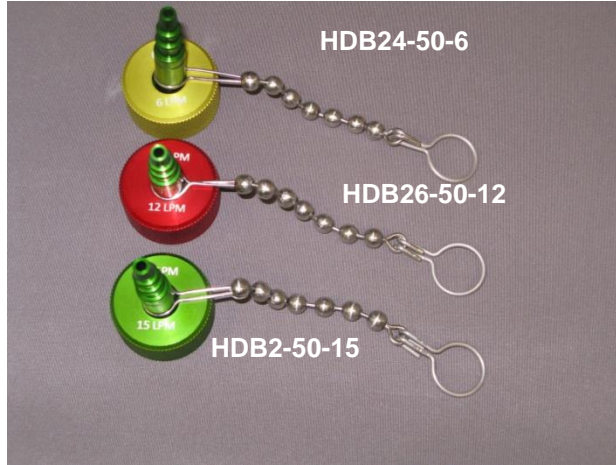

**Ordering Information:**

<p><b>50 PSI Green Knurled Nut</b></p> <p>HBD2-50-0.5    0.5 LPM @ 50 PSI</p> <p>HBD2-50-1      1 LPM @ 50PSI</p> <p>HBD2-50-2      2 LPM @ 50PSI</p> <p>HBD2-50-3      3 LPM @ 50PSI</p> <p>HBD2-50-4      4 LPM @ 50PSI</p> <p>HBD2-50-6      6 LPM @ 50PSI</p> <p>HBD2-50-8      8 LPM @ 50PSI</p> <p>HBD2-50-10    10 LPM @ 50PSI</p> <p>HBD2-50-12    12 LPM @ 50PSI</p> <p>HBD2-50-15    15 LPM @ 50PSI</p> <p>HBD2-50-20    20 LPM @ 50PSI</p> <p>HBD2-50-25    25 LPM @ 50PSI</p>	<p><b>50 PSI Yellow Knurled Nut</b></p> <p>HBD24-50-0.5   0.5 LPM @ 50 PSI</p> <p>HBD24-50-1     1 LPM @ 50 PSI</p> <p>HBD24-50-2     2 LPM @ 50 PSI</p> <p>HBD24-50-3     3 LPM @ 50 PSI</p> <p>HBD24-50-4     4 LPM @ 50 PSI</p> <p>HBD24-50-6     6 LPM @ 50 PSI</p> <p>HBD24-50-8     8 LPM @ 50 PSI</p> <p>HBD24-50-10    10 LPM @ 50 PSI</p> <p>HBD24-50-12    12 LPM @ 50 PSI</p> <p>HBD24-50-15    15 LPM @ 50 PSI</p> <p>HBD24-50-20    20 LPM @ 50 PSI</p> <p>HBD24-50-25    25 LPM @ 50 PSI</p>	<p><b>50 PSI Red Knurled Nut</b></p> <p>HBD26-50-0.5   0.5 LPM @ 50 PSI</p> <p>HBD26-50-1     1 LPM @ 50 PSI</p> <p>HBD26-50-2     2 LPM @ 50 PSI</p> <p>HBD26-50-3     3 LPM @ 50 PSI</p> <p>HBD26-50-4     4 LPM @ 50 PSI</p> <p>HBD26-50-6     6 LPM @ 50 PSI</p> <p>HBD26-50-8     8 LPM @ 50 PSI</p> <p>HBD26-50-10    10 LPM @ 50 PSI</p> <p>HBD26-50-12    12 LPM @ 50 PSI</p> <p>HBD26-50-15    15 LPM @ 50 PSI</p> <p>HBD26-50-20    20 LPM @ 50 PSI</p> <p>HBD26-50-25    25 LPM @ 50 PSI</p>
<p><b>20 PSI Green Knurled Nut</b></p> <p>HBD2-20-1      1 LPM @ 20PSI</p> <p>HBD2-20-2      2 LPM @ 20PSI</p> <p>HBD2-20-4      4 LPM @ 20PSI</p> <p>HBD2-20-8      8 LPM @ 20PSI</p> <p>HBD2-20-12     12 LPM @ 20PSI</p>	<p><b>20 PSI Yellow Knurled Nut</b></p> <p>HBD24-20-1     1 LPM @ 20 PSI</p> <p>HBD24-20-2     2 LPM @ 20 PSI</p> <p>HBD24-20-4     4 LPM @ 20 PSI</p> <p>HBD24-20-8     8 LPM @ 20 PSI</p> <p>HBD24-20-12    12 LPM @ 20 PSI</p>	<p><b>20 PSI Red Knurled Nut</b></p> <p>HBD26-20-1     1 LPM @ 20 PSI</p> <p>HBD26-20-2     2 LPM @ 20 PSI</p> <p>HBD26-20-4     4 LPM @ 20 PSI</p> <p>HBD26-20-8     8 LPM @ 20 PSI</p> <p>HBD26-20-12    12 LPM @ 20 PSI</p>
<p><b>58 PSI Green Knurled Nut</b></p> <p>HBD2-58-1      1 LPM @ 58PSI</p> <p>HBD2-58-2      2 LPM @ 58PSI</p> <p>HBD2-58-4      4 LPM @ 58PSI</p>	<p><b>58 PSI Yellow Knurled Nut</b></p> <p>HBD24-58-1     1 LPM @ 58 PSI</p> <p>HBD24-58-2     2 LPM @ 58 PSI</p> <p>HBD24-58-4     4 LPM @ 58 PSI</p>	<p><b>58 PSI Red Knurled Nut</b></p> <p>HBD26-20-1     1 LPM @ 58 PSI</p> <p>HBD26-20-2     2 LPM @ 58 PSI</p> <p>HBD26-20-4     4 LPM @ 58 PSI</p>



## FloGripp Post Valve Knob

The FloGripp replaces the Post Valve Toggle Handle

- Eliminates need for Post Valve Wrenches
- Provides easy ON and OFF control
- Eliminates risk from sharp surfaces on toggle style
- Simple to upgrade. Not necessary to remove valve from cylinder tank during installation.
- Broken Toggle Post Valves can be repurposed, saving \$\$\$\$\$

Part Number	Description	
PVX30B	FloGripp Knob Assembly Kit	

